

# Sampling of Linear Systems

Real-Time Systems, Lecture 6

Karl-Erik Årzén  
 26 January 2018  
 Lund University, Department of Automatic Control

## Lecture 6: Sampling of Linear Systems

[IFAC PB Ch. 1, Ch. 2, and Ch. 3 (to pg 23)]

- Effects of Sampling
- Sampling a Continuous-Time State-Space Model
- Difference Equations
- State-Space Models in Discrete Time

1

### Textbook

The main text material for this part of the course is:  
 Wittenmark, Åström, Årzén: *IFAC Professional Brief: Computer Control: An Overview*, (Educational Version 2016) ("IFAC PB")

- Summary of the digital control parts of Åström and Wittenmark: *Computer Controlled Systems* (1997)
- Some new material

Chapters 10 and 11 are not part of this course (but can be useful in other courses, e.g., Predictive Control)

Chapters 7, 13 and 14 partly overlap with RTCS.

2

### Sampled Control Theory

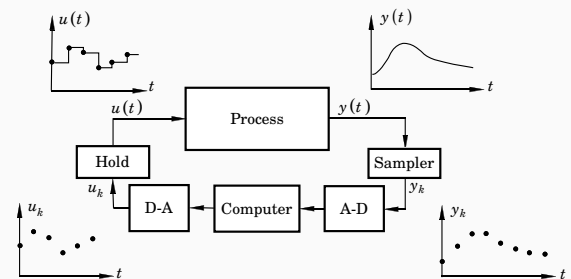

- System theory analogous to continuous-time linear systems
- Better control performance can be achieved (compared to discretization of continuous-time design)
- Problems with aliasing, intersample behaviour

3

### Sampling

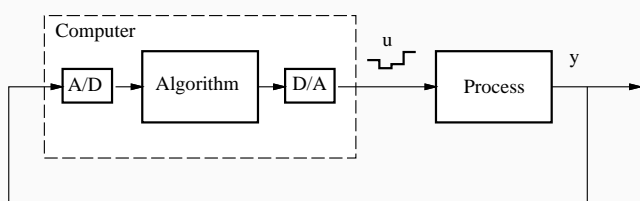

AD-converter acts as sampler

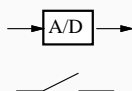

Regular/periodic sampling:

- Constant sampling interval  $h$
- Sampling instants:  $t_k = kh$

4

### Hold Devices

Zero-Order Hold (ZOH) almost always used. DA-converter acts as hold device  $\Rightarrow$  piecewise constant control signals

First-Order Hold (FOH):

- Signal between the conversions is a linear extrapolation

$$f(t) = f(kh) + \frac{t - kh}{h}(f(kh + h) - f(kh)) \quad kh \leq t < kh + h$$

- Advantages:
  - Better reconstruction
  - Continuous output signal
- Disadvantages:
  - $f(kh + h)$  must be available at time  $kh$
  - More involved controller design
  - Not supported by standard DA-converters

5

## Hold Devices

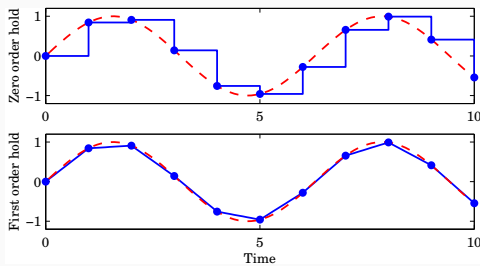

In IFAC PB there are quite a lot of results presented for the first-order hold case. These are not part of this course.

6

## Dynamic Effects of Sampling

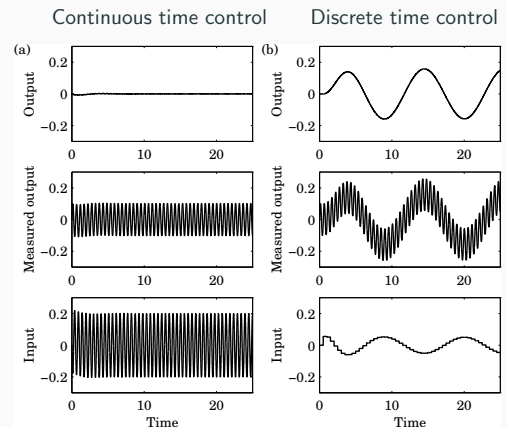

Sampling of high-frequency measurement noise may create new frequencies!

7

## Aliasing

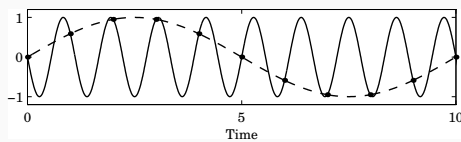

- Sampling frequency [rad/s]:  $\omega_s = 2\pi/h$
- Nyquist frequency [rad/s]:  $\omega_N = \omega_s/2$

Frequencies above the Nyquist frequency are folded and appear as low-frequency signals.

Calculation of "fundamental alias" for an original frequency  $\omega_1$ :

$$\omega = |(\omega_1 + \omega_N) \bmod (\omega_s) - \omega_N|$$

8

## Aliasing – Real World Example

Feed water heating in a ship boiler

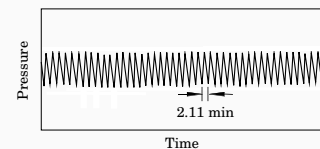
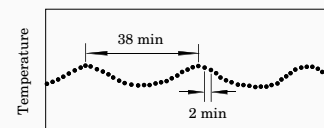
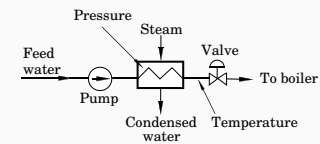

9

## Prefiltering

Analog low-pass filter needed to remove high-frequency measurement noise before sampling

Example:

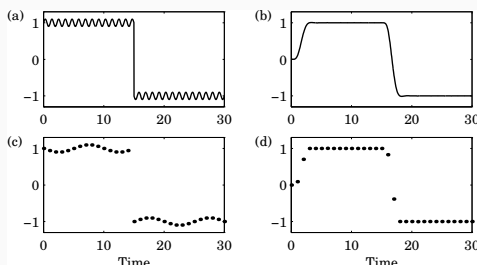

(a), (c):  $f_1 = 0.9 \text{ Hz}$ ,  $f_N = 0.5 \text{ Hz} \Rightarrow f_{alias} = 0.1 \text{ Hz}$

(b), (d): 6th order Bessel prefilter with bandwidth  $f_B = 0.25 \text{ Hz}$

More on aliasing in Lecture 11.

10

## Time Dependence in Sampled-Data Systems

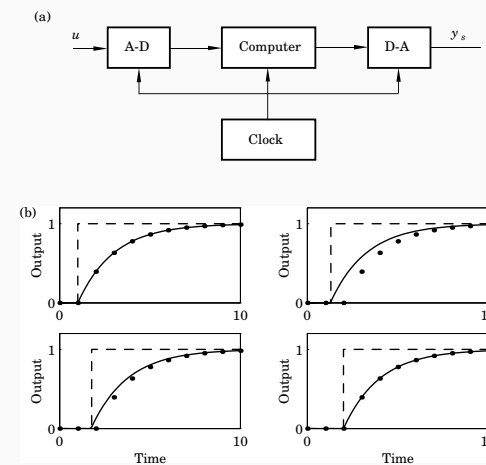

11

## Sample and Hold Approximation

A sampler in direct combination with a ZOH device gives an average delay of  $h/2$

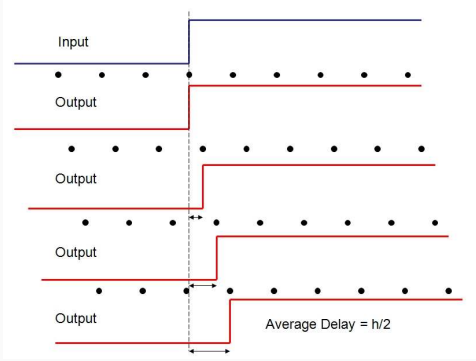

12

## Design Approaches for Computer Control

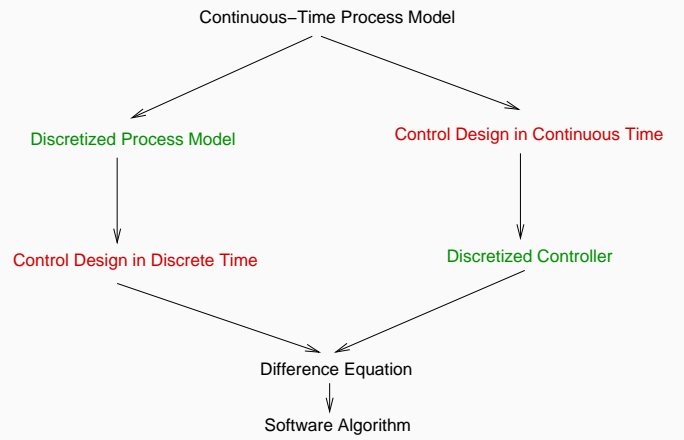

13

## Design Approaches for Computer Control

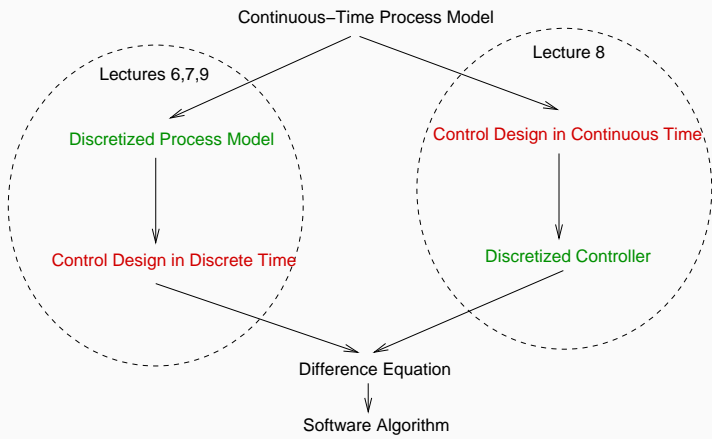

14

## Sampled Control Theory

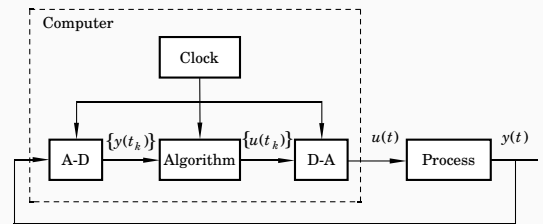

Basic idea: Look at the sampling instances only

- Stroboscopic model
- Look upon the process from the computer's point of view

15

## Disk Drive Example

Control of the arm of a disk drive

$$G(s) = \frac{k}{Js^2}$$

Continuous time controller

$$U(s) = \frac{bK}{a}U_c(s) - K\frac{s+b}{s+a}Y(s)$$

Discrete time controller (continuous time design + discretization)

$$u(t_k) = K\left(\frac{b}{a}u_c(t_k) - y(t_k) + x(t_k)\right)$$

$$x(t_{k+1}) = x(t_k) + h\left((a-b)y(t_k) - ax(t_k)\right)$$

(Continuous-time poles placed according to  $P(s) = s^3 + 2\omega_0 s^2 + 2\omega_0^2 s + \omega_0^3$ )

16

## Disk Drive Example

```
uc := adin(1)
y := adin(2)
u := K*(b/a*uc-y+x)
daout(u)
x := x+h*((a-b)*y-a*x)
```

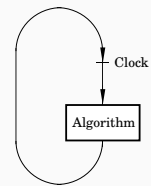

Sampling period  $h = 0.2/\omega_0$

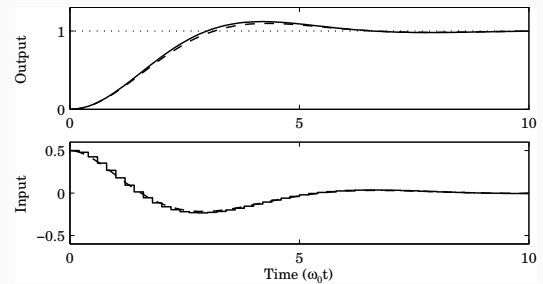

17

## Increased Sampling Period

(a)  $h = 0.5/\omega_0$ , (b)  $h = 1.08/\omega_0$

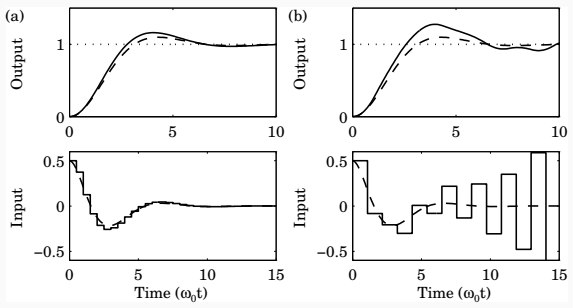

## Better Performance?

Deadbeat control,  $h = 1.4/\omega_0$

$$u(t_k) = t_0 u_c(t_k) + t_1 u_c(t_{k-1}) - s_0 y(t_k) - s_1 y(t_{k-1}) - r_1 u(t_{k-1})$$

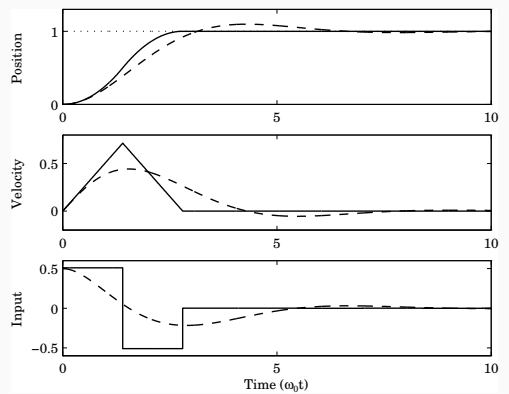

## Better Performance?

Deadbeat: The output reaches the reference value after  $n$  samples ( $n = \text{model order}$ )

No counterpart in continuous time

However, long sampling periods also have problems

- Open loop between samples
- Sensitive to model errors
- Disturbance and reference changes that occur between samples will remain undetected until the next sample

## Sampling of Linear Systems

Look at the system from the point of view of the computer

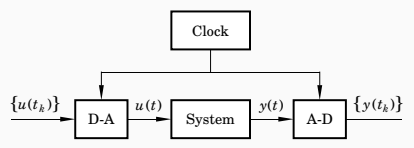

Zero-order-hold sampling

- Let the inputs be piecewise constant
- Look at the sampling points only

## Continuous-Time System Model

Linear time-invariant system model in continuous time:

$$\begin{cases} \frac{dx}{dt} = Ax + Bu \\ y = Cx + Du \end{cases}$$

Solution (see basic course in control):

$$x(t) = e^{At}x(t_0) + \int_{t_0}^t e^{A(t-\tau)}Bu(\tau)ds$$

$$y(t) = Ce^{At}x(t_0) + C \int_{t_0}^t e^{A(t-\tau)}Bu(\tau)ds + Du(t)$$

Use this to derive a discrete-time model

## Sampling a Continuous-Time System

Solve the system equation

$$\frac{dx(t)}{dt} = Ax(t) + Bu(t)$$

from time  $t_k$  to time  $t$  under the assumption that  $u$  is piecewise constant (ZOH sampling)

$$\begin{aligned} x(t) &= e^{A(t-t_k)}x(t_k) + \int_{t_k}^t e^{A(t-s')}Bu(s')ds' \\ &= e^{A(t-t_k)}x(t_k) + \int_{t_k}^t e^{A(t-s')}ds' Bu(t_k) \quad (Bu(t_k) \text{ const.}) \\ &= e^{A(t-t_k)}x(t_k) + \int_{t-t_k}^0 -e^{As}ds Bu(t_k) \quad (\text{var. change } s = t - s') \\ &= e^{A(t-t_k)}x(t_k) + \int_0^{t-t_k} e^{As}ds Bu(t_k) \quad (\text{change int. limits}) \\ &= \Phi(t, t_k)x(t_k) + \Gamma(t, t_k)u(t_k) \end{aligned}$$

### The General Case

$$x(t_{k+1}) = \Phi(t_{k+1}, t_k)x(t_k) + \Gamma(t_{k+1}, t_k)u(t_k)$$

$$y(t_k) = Cx(t_k) + Du(t_k)$$

where

$$\Phi(t_{k+1}, t_k) = e^{A(t_{k+1}-t_k)}$$

$$\Gamma(t_{k+1}, t_k) = \int_0^{t_{k+1}-t_k} e^{As} ds B$$

No assumption about periodic sampling

24

### Periodic Sampling

Assume periodic sampling, i.e.  $t_k = kh$ . Then

$$x(kh + h) = \Phi x(kh) + \Gamma u(kh)$$

$$y(kh) = Cx(kh) + Du(kh)$$

where

$$\Phi = e^{Ah}$$

$$\Gamma = \int_0^h e^{As} ds B$$

NOTE: Time-invariant linear system!  
No approximations

25

### Example: Sampling of Double Integrator

$$\frac{dx}{dt} = \begin{pmatrix} 0 & 1 \\ 0 & 0 \end{pmatrix} x + \begin{pmatrix} 0 \\ 1 \end{pmatrix} u$$

$$y = \begin{pmatrix} 1 & 0 \end{pmatrix} x$$

Periodic sampling with interval  $h$ :

$$\Phi = e^{Ah} = I + Ah + A^2h^2/2 + \dots$$

$$= \begin{pmatrix} 1 & 0 \\ 0 & 1 \end{pmatrix} + \begin{pmatrix} 0 & h \\ 0 & 0 \end{pmatrix} = \begin{pmatrix} 1 & h \\ 0 & 1 \end{pmatrix}$$

$$\Gamma = \int_0^h \begin{pmatrix} 1 & s \\ 0 & 1 \end{pmatrix} \begin{pmatrix} 0 \\ 1 \end{pmatrix} ds = \int_0^h \begin{pmatrix} s \\ 1 \end{pmatrix} ds = \begin{pmatrix} h^2/2 \\ h \end{pmatrix}$$

26

### Calculating the Matrix Exponential

Pen and paper for small systems

$$\Phi = \mathcal{L}^{-1} (sI - A)^{-1}$$

Matlab for large systems (numeric or symbolic calculations)

```
>> syms h
>> A = [0 1; 0 0];
>> expm(A*h)

ans =

[ 1, h]
[ 0, 1]
```

27

### Calculating the Matrix Exponential

One can show that

$$\begin{pmatrix} \Phi & \Gamma \\ 0 & I \end{pmatrix} = \exp \left( \begin{pmatrix} A & B \\ 0 & 0 \end{pmatrix} h \right)$$

Simultaneous calculation of  $\Phi$  and  $\Gamma$

```
>> syms h
>> A = [0 1; 0 0];
>> B = [0; 1];
>> expm([A B; zeros(1, size(A)) 0]*h)

ans =

[ 1, h, 1/2*h^2]
[ 0, 1, h]
[ 0, 0, 1]
```

28

### Sampling of System with Input Time Delay

$$\begin{cases} \frac{dx}{dt} = Ax(t) + Bu(t - \tau) \\ y(t) = Cx(t) + Du(t) \end{cases}$$

29

### Sampling of System with Input Time Delay

Input delay  $\tau \leq h$  (assumed to be constant)

$$\frac{dx(t)}{dt} = Ax(t) + Bu(t - \tau)$$

$$x(kh + h) - \Phi x(kh) = \int_{kh}^{kh+h} e^{A(kh+h-s')} Bu(s' - \tau) ds'$$

$$= \int_{kh}^{kh+\tau} e^{A(kh+h-s')} ds' B u(kh - h) + \int_{kh+\tau}^{kh+h} e^{A(kh+h-s')} ds' B u(kh)$$

$$= \underbrace{e^{A(h-\tau)} \int_0^\tau e^{As} ds B}_{\Gamma_1} u(kh - h) + \underbrace{\int_0^{h-\tau} e^{As} ds B}_{\Gamma_0} u(kh)$$

$$x(kh + h) = \Phi x(kh) + \Gamma_1 u(kh - h) + \Gamma_0 u(kh)$$

30

### Sampling of System with Input Time Delay

Introduce a new state variable  $z(kh) = u(kh - h)$

Sampled system in state-space form

$$\begin{pmatrix} x(kh + h) \\ z(kh + h) \end{pmatrix} = \begin{pmatrix} \Phi & \Gamma_1 \\ 0 & 0 \end{pmatrix} \begin{pmatrix} x(kh) \\ z(kh) \end{pmatrix} + \begin{pmatrix} \Gamma_0 \\ I \end{pmatrix} u(kh)$$

The approach can be extended also for  $\tau > h$

- $h < \tau \leq 2h \Rightarrow$  two extra state variables, etc.

Similar techniques can also be used to handle output delays and delays that are internal in the plant.

In continuous-time delays mean infinite-dimensional systems. In discrete-time the sampled system is a finite-dimensional system  $\Rightarrow$  easier to handle

31

### Example – Double Integrator with Input Delay $\tau \leq h$

$$\Phi = e^{Ah} = \begin{pmatrix} 1 & h \\ 0 & 1 \end{pmatrix}$$

$$\Gamma_1 = e^{A(h-\tau)} \int_0^\tau e^{As} ds B = \begin{pmatrix} 1 & h-\tau \\ 0 & 1 \end{pmatrix} \begin{pmatrix} \tau^2/2 \\ \tau \end{pmatrix} = \begin{pmatrix} h\tau - \tau^2/2 \\ \tau \end{pmatrix}$$

$$\Gamma_0 = \int_0^{h-\tau} e^{As} ds B = \begin{pmatrix} (h-\tau)^2/2 \\ h-\tau \end{pmatrix}$$

$$x(kh + h) = \Phi x(kh) + \Gamma_1 u(kh - h) + \Gamma_0 u(kh)$$

32

### Solution of the Discrete System Equation

$$\begin{aligned} x(1) &= \Phi x(0) + \Gamma u(0) \\ x(2) &= \Phi x(1) + \Gamma u(1) \\ &= \Phi^2 x(0) + \Phi \Gamma u(0) + \Gamma u(1) \\ &\vdots \\ x(k) &= \Phi^k x(0) + \sum_{j=0}^{k-1} \Phi^{k-j-1} \Gamma u(j) \\ y(k) &= C \Phi^k x(0) + \sum_{j=0}^{k-1} C \Phi^{k-j-1} \Gamma u(j) + Du(k) \end{aligned}$$

Two parts, one depending on the initial condition  $x(0)$  and one that is a weighted sum of the inputs over the interval  $[0, k - 1]$

33

### Stability

**Definition**

The linear discrete-time system

$$x(k + 1) = \Phi x(k), \quad x(0) = x_0$$

is *asymptotically stable* if the solution  $x(k)$  satisfies  $\|x(k)\| \rightarrow 0$  as  $k \rightarrow \infty$  for all  $x_0 \in \mathbb{R}^n$ .

**Theorem**

A discrete-time linear system is asymptotically stable if and only if  $|\lambda_i(\Phi)| < 1$  for all  $i = 1, \dots, n$ .

34

The matrix  $\Phi$  can, if it has distinct eigenvalues, be written in the form

$$\Phi = U \begin{bmatrix} \lambda_1 & & * \\ & \ddots & \\ 0 & & \lambda_n \end{bmatrix} U^{-1}. \quad \text{Hence } \Phi^k = U \begin{bmatrix} \lambda_1^k & & * \\ & \ddots & \\ 0 & & \lambda_n^k \end{bmatrix} U^{-1}.$$

The diagonal elements are the eigenvalues of  $\Phi$ .

$\Phi^k$  decays exponentially if and only if  $|\lambda_i(\Phi)| < 1$  for all  $i$ , i.e. if all the eigenvalues of  $\Phi$  are strictly inside the unit circle.

This is the asymptotic stability condition for discrete-time systems

If  $\Phi$  has at least one eigenvalue outside the unit circle then the system is unstable

If  $\Phi$  has eigenvalues on the unit circle then the multiplicity of these eigenvalues decides if the system is stable or unstable

Eigenvalues obtained from the characteristic equation

$$\det(\lambda I - \Phi) = 0$$

35

## Stability Regions

In continuous time the stability region is the complex left half plane, i.e., the system is asymptotically stable if all the poles are strictly in the left half plane.

In discrete time the stability region is the unit circle.

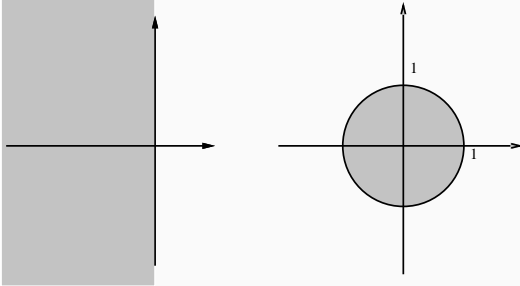

## The Sampling-Time Convention

In many cases we are only interested in the behaviour of the discrete-time system and not so much how the discrete-time system has been obtained, e.g., through ZOH-sampling of a continuous-time system.

For simplicity, then the sampling time is used as the time unit,  $h = 1$ , and the discrete-time system can be described by

$$\begin{aligned} x(k+1) &= \Phi x(k) + \Gamma u(k) \\ y(k) &= Cx(k) + Du(k) \end{aligned}$$

Hence, the argument of the signals is not time but instead the number of sampling intervals.

This is known as the *sampling-time convention*.

## Discrete-time systems may converge in finite time

Consider the discrete-time system

$$x(k+1) = \begin{pmatrix} 0 & 1/2 \\ 0 & 0 \end{pmatrix} x(k)$$

We then have that

$$x(2) = 0$$

for all  $x(0)$ . Thus, the system converges in finite time!

$\Phi$  has its eigenvalues in the origin  $\Rightarrow$  *Deadbeat*

Finite-time convergence is impossible for continuous-time linear systems. Hence, the above system cannot have been obtained by sampling a continuous-time system (However, it can be obtained through feedback applied to a continuous-time system, see Lecture 9).

The possibility to have finite convergence (deadbeat) is one of the few differences between discrete-time and continuous-time systems.

## Pulse Response

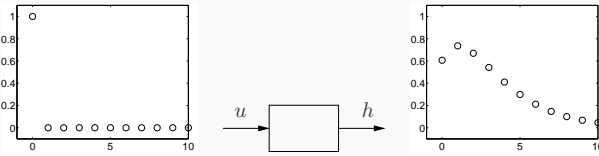

$$\begin{aligned} x(1) &= \Gamma & x(2) &= \Phi\Gamma & x(3) &= \Phi^2\Gamma & \dots \\ h(1) &= C\Gamma & h(2) &= C\Phi\Gamma & h(3) &= C\Phi^2\Gamma & \dots \\ h(0) &= D & h(k) &= C\Phi^{k-1}\Gamma & k &= 1, 2, 3, \dots \end{aligned}$$

(Continuous-time:  $h(t) = Ce^{At}B + D\delta(t) \quad t \geq 0$ )

## Convolution

Swedish: Faltning

Continuous time:

$$(h * u)(t) = \int_0^t h(t-s)u(s)ds \quad t \geq 0$$

Discrete time:

$$(h * u)(k) = \sum_{j=0}^k h(k-j)u(j) \quad k = 0, 1, \dots$$

## Solution to the System Equation

The solution to the system equation

$$y(k) = C\Phi^k x(0) + \sum_{j=0}^{k-1} C\Phi^{k-j-1}\Gamma u(j) + Du(k)$$

can be written in terms of the pulse response

$$y(k) = C\Phi^k x(0) + (h * u)(k)$$

Two parts, one that depends on the initial conditions and one that is a convolution between the pulse response and the input signal

### Reachability

Continuous-time systems only have one reachability concept, whereas discrete-time systems have two (consequence of deadbeat)

**Definition**  
A discrete-time linear system is *reachable* if for any final state  $x_f$ , it is possible to find  $u(0), u(1), \dots, u(k-1)$  which drives the system state from  $x(0) = 0$  to  $x(k) = x_f$  for some finite value of  $k$ .

**Theorem**  
The discrete-time linear system is reachable if and only if  $\text{rank}(W_C) = n$  where

$$W_C = \begin{pmatrix} \Gamma & \Phi\Gamma & \dots & \Phi^{n-2}\Gamma & \Phi^{n-1}\Gamma \end{pmatrix}$$

is the reachability matrix and  $n$  is the order of the system.

Corresponds to continuous-time reachability.

42

### Controllability

**Definition**  
A discrete-time linear system is *controllable* if for any initial state  $x(0)$ , it is possible to find  $u(0), u(1), \dots, u(k-1)$  so that  $x(k) = 0$  for some finite value of  $k$ .

If a system is reachable it is also controllable, but there are discrete-time linear systems which are controllable but not reachable. One such example is

$$x(k+1) = \begin{pmatrix} 0 & 1/2 \\ 0 & 0 \end{pmatrix} x(k) + \begin{pmatrix} 1 \\ 0 \end{pmatrix} u(k)$$

Although  $W_C$  does not have full rank,  $u(k) = 0$  yields  $x(2) = 0$  no matter which  $x(0)$ .

A system is *completely controllable* if it is controllable in  $n$  steps

A system is completely controllable if and only if all the eigenvalues of the unreachable part of the system are at the origin

43

### Stabilizability

**Definition**  
A discrete-time linear system is *stabilizable* if the states of the system can be driven asymptotically to the origin

**Theorem**  
A discrete-time linear system is stabilizable if and only if all the eigenvalues of its unreachable part are strictly inside the unit circle

Reachability  $\Rightarrow$  Controllability  $\Rightarrow$  Stabilizability

44

### Observability (again two concepts)

**Definition**  
The pair of states  $x_1 \neq x_2 \in \mathbb{R}^n$  is called *indistinguishable* from the output  $y$  if for any input sequence  $u$

$$y(k, x_1, u) = y(k, x_2, u), \forall k \geq 0$$

A linear system is called *observable* if no pair of states are indistinguishable from the output

**Theorem**  
The discrete-time linear system is observable if and only if  $\text{rank}(W_O) = n$  where

$$W_O = \begin{pmatrix} C \\ C\Phi \\ \vdots \\ C\Phi^{n-1} \end{pmatrix}$$

is the observability matrix and  $n$  is the system order

45

### Reconstructability

**Definition**  
A discrete-time linear system is *reconstructable* if there is a finite  $k$  such that knowledge about inputs  $u(0), u(1), \dots, u(k-1)$  and outputs  $y(0), y(1), \dots, y(k-1)$  are sufficient for determining the initial state  $x(0)$

**Theorem**  
A system is reconstructable if and only if all the eigenvalues of the nonobservable part are zero

A system that is observable is also reconstructable

Reconstructability corresponds to continuous-time observability

46

### Detectability

**Definition**  
A system is *detectable* if the only unobservable states are such that they decay to the origin, i.e., the corresponding eigenvalues are asymptotically stable.

Observability  $\Rightarrow$  Reconstructability  $\Rightarrow$  Detectability

47



Duality	Kalman decomposition
---------	----------------------

There is a duality between the reachability and the observability properties:

Reachable	Observable
Controllable	Reconstructable
Completely Controllable	Completely Reconstructable (in $n$ steps)
Stabilizable	Detectable (asymptotically)

We will return to these concepts in Lecture 9.

In the same way as for continuous-time linear systems one can decompose a system into (un)controllable and (un)observable subsystems, using a state transformation  $z = Tx$

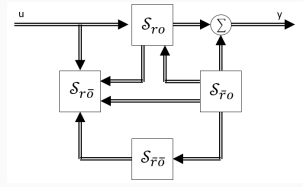

- where
- $S_{ro}$  is reachable and observable
  - $S_{r\bar{o}}$  is reachable but not observable
  - $S_{\bar{r}o}$  is not reachable but observable
  - $S_{\bar{r}\bar{o}}$  is neither reachable nor observable

Difference Equations	From Difference Equation to Reachable Canonical Form
----------------------	--

Difference equation of order  $n$ :

$$y(k) + a_1y(k-1) + \dots + a_ny(k-n) = b_1u(k-1) + \dots + b_nu(k-n)$$

Differential equation of order  $n$ :

$$\frac{d^n y}{dt^n} + a_1 \frac{d^{n-1} y}{dt^{n-1}} + \dots + a_n y = b_1 \frac{d^{n-1} u}{dt^{n-1}} + \dots + b_n u$$

$$y(k) + a_1y(k-1) + \dots + a_ny(k-n) = b_1u(k-1) + \dots + b_nu(k-n)$$

Start with  $b_1 = 1$  and  $b_2 = \dots = b_n = 0$  in difference equation above

Put  $k \rightarrow k+1$ , and  $y(k) = z(k)$ :

$$z(k+1) + a_1z(k) + \dots + a_nz(k-n+1) = u(k)$$

$$x(k) = [z(k) \quad z(k-1) \quad \dots \quad z(k-n+1)]^T$$

gives

$$x(k+1) = \begin{bmatrix} z(k+1) \\ z(k) \\ \vdots \\ z(k-n+2) \end{bmatrix} = \begin{bmatrix} -a_1 & -a_2 & \dots & -a_n \\ 1 & 0 & \dots & 0 \\ & \ddots & & \vdots \\ & & & 1 & 0 \end{bmatrix} x(k) + \begin{bmatrix} 1 \\ 0 \\ \vdots \\ 0 \end{bmatrix} u(k)$$

$$z(k) = [1 \quad 0 \quad \dots \quad 0] x(k)$$

Reachable Canonical Form	State-Space Realizations
--------------------------	--------------------------

Let

$$y(k) = b_1z(k) + b_2z(k-1) + \dots + b_nz(k-n)$$

Then (think superposition!)

$$x(k+1) = \begin{bmatrix} -a_1 & -a_2 & \dots & -a_n \\ 1 & 0 & \dots & 0 \\ & \ddots & & \vdots \\ & & & 1 & 0 \end{bmatrix} x(k) + \begin{bmatrix} 1 \\ 0 \\ \vdots \\ 0 \end{bmatrix} u(k)$$

$$y(k) = [b_1 \quad b_2 \quad \dots \quad b_n] x(k)$$

which corresponds to

$$y(k) + a_1y(k-1) + \dots + a_ny(k-n) = b_1u(k-1) + \dots + b_nu(k-n)$$

By choosing different state variables, different state-space models can be derived which all describe the same input-output relation

A realization is minimal if the number of states is equal to  $n$ .

In the *direct form* the states are selected as the old values of  $y$  together with the old values of  $u$  – non-minimal.

Some realizations have better numerical properties than others, see Lecture 11.

## Some useful Matlab commands

```
>> A = [0 1;0 0]
>> B = [0;1]
>> C = [1 0]
>> D = 0
>> contsys = ss(A,B,C,D)
>> h = 0.1
>> discsys = c2d(contsys,h) % ZOH sampling
>> pole(discsys)
>> impulse(discsys)
>> step(discsys)
```